

**1** White side up

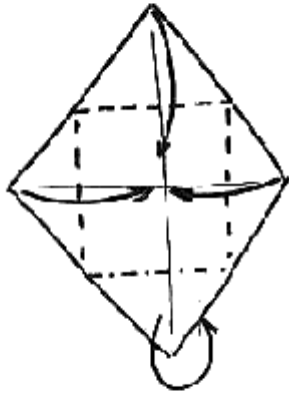

**2**

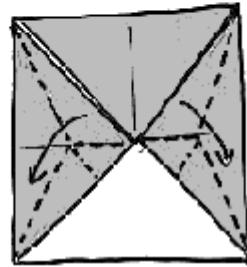

**Rabbit ear folds**

**3**

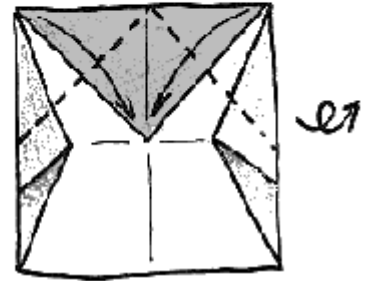

**Turn over**

**4**

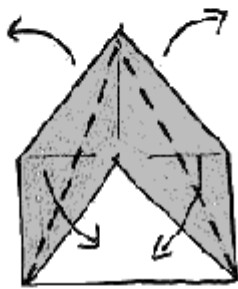

**Bring flaps  
from behind**

**5**

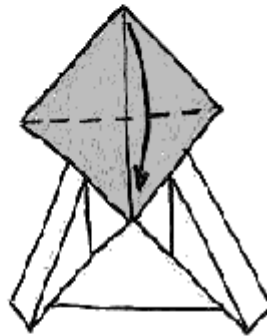

**Tuck into pocket  
behind**

**6**

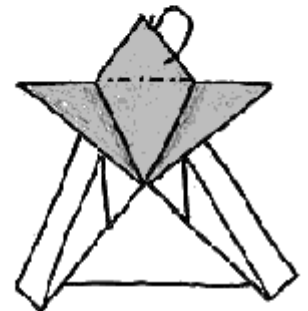

**7**

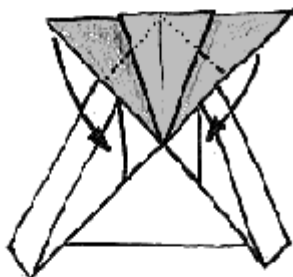

**Reverse folds**

**8**

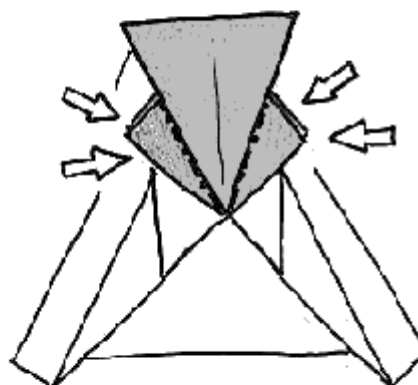

**Four more  
Reverse folds**

**9**

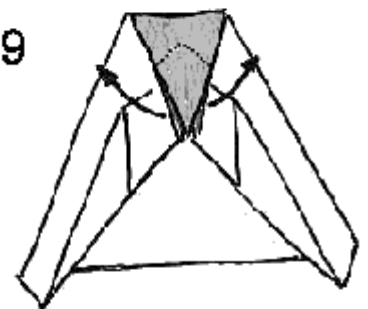

**Form ears**

10

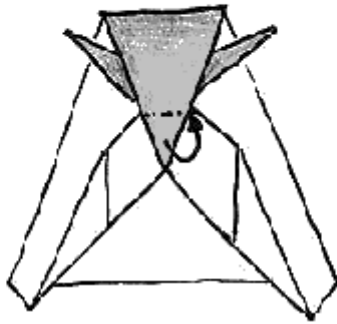

Fold flap behind

11

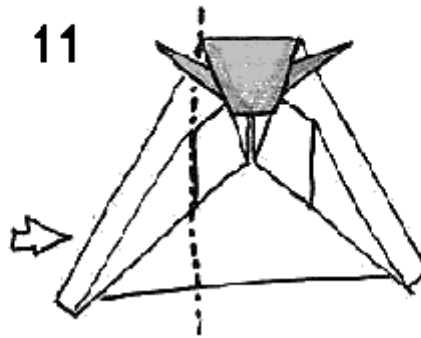

Reverse fold  
inside model

12

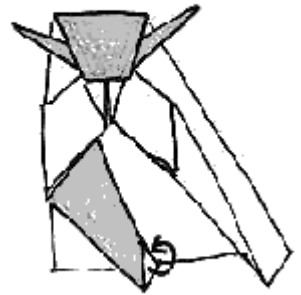

Wrap white  
layer to behind

13

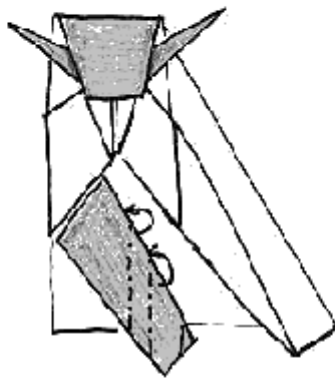

14

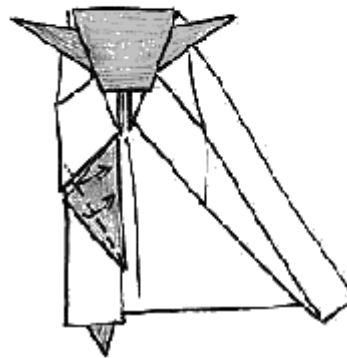

Make this flap white with  
a valley fold. A reverse  
fold under the arm may  
be needed

15



Outside reverse  
fold to form hand

16

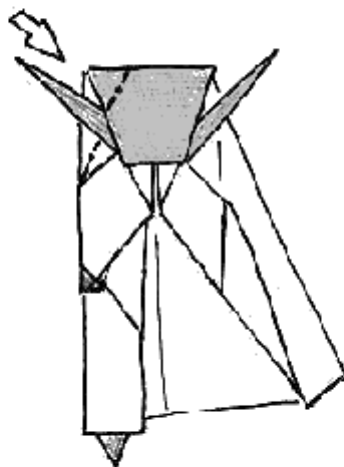

Closed sink

17

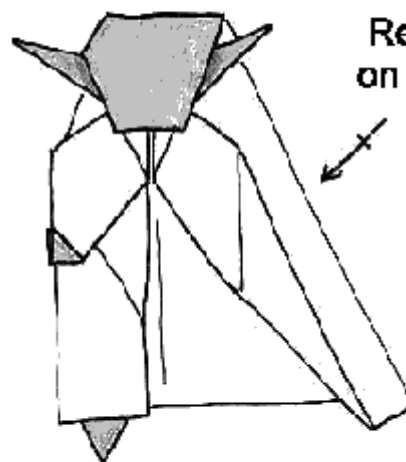

Repeat steps 11 - 16  
on the right side of the  
model

18

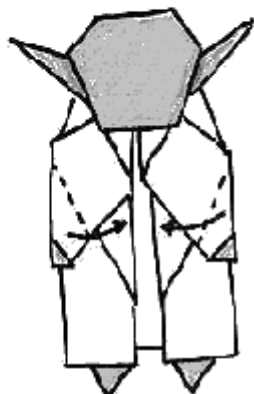

Fold arms to centre

19

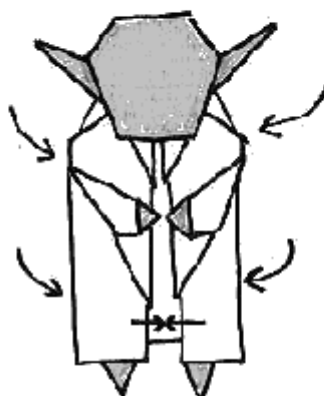

Round body by bringing front of robes together

20

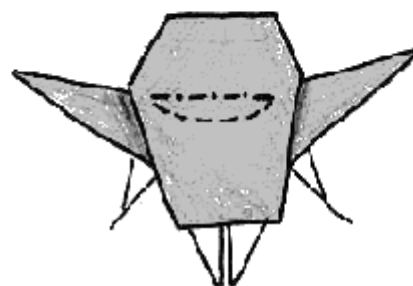

Pinch these folds with thumbnail

21

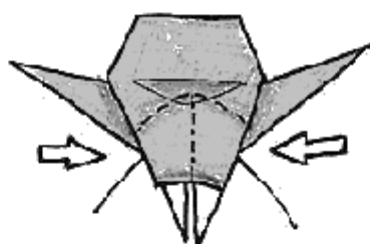

Pinch between fingers to form face...

22

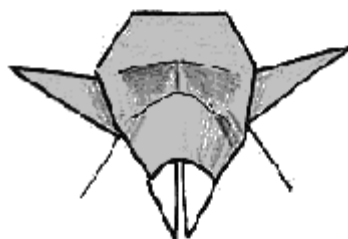

...like so

Finished  
Yoda

